

Zubehör für Universalprüfmaschinen

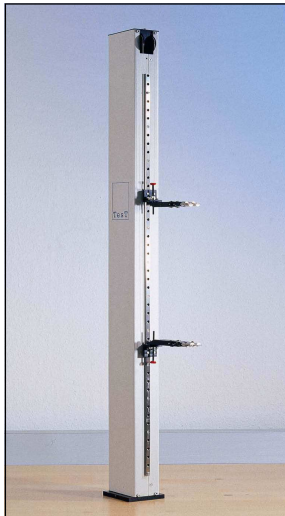

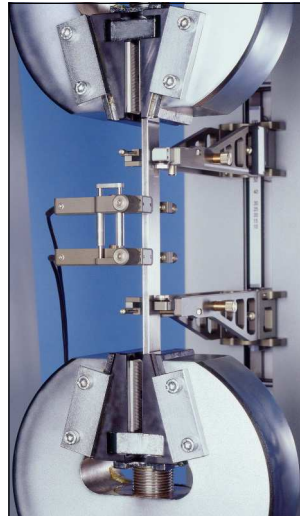

**Langweg-
Dehnungsaufnehmer**



**Langweg- und Quer-
Dehnungsaufnehmer**



**Vollautomatischer
Dehnungsaufnehmer**

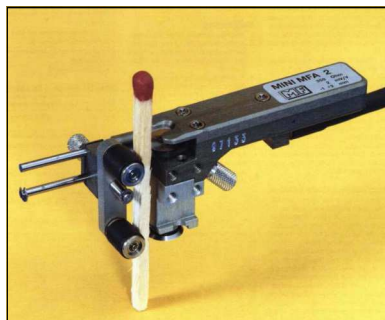

**Anklemm-Dehnungsaufnehmer
Mini**

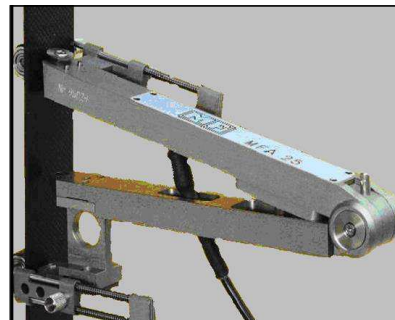

Anklemm-Dehnungsaufnehmer



Temperierkammern und Öfen für die Material- und Bauteilprüfung unter Temperatureinfluss





Druckplatten



Keilspannzeuge



Keilspannzeuge

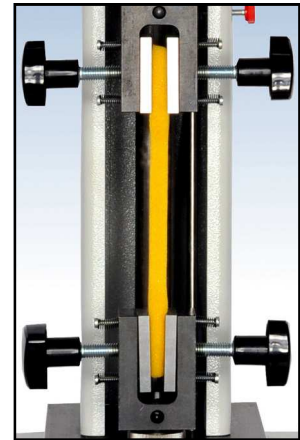

Schraubklemmen



Zughaken drehbar



Exzenter-Spannzeug



Gabelköpfe

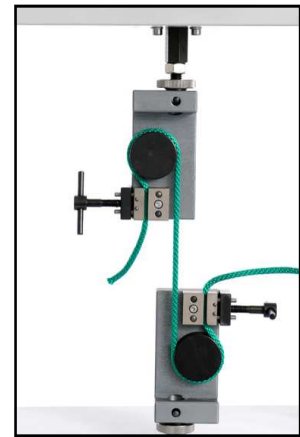

Seilspannzeuge



Hydr. Spannzeug



**Bauteilprüfvorrichtung
z.B. für Spritzen**



Biegevorrichtung



Durchstichvorrichtung

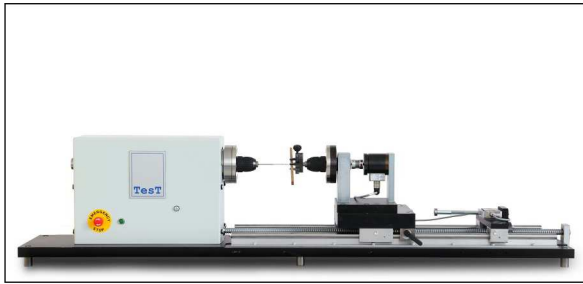

Kombinierte Prüfmaschine mit gleichzeitiger Axial- und Torsionsbelastung

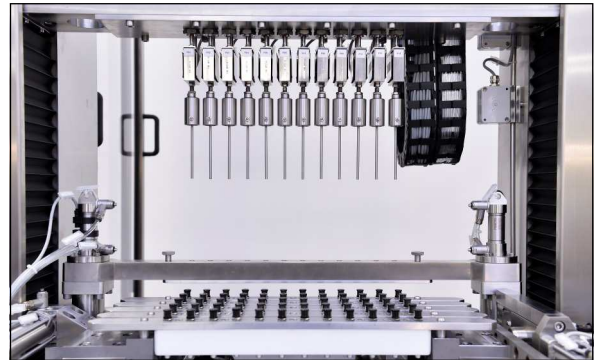

Prüfung von Injektions-Ampullen (Medizintechnik)

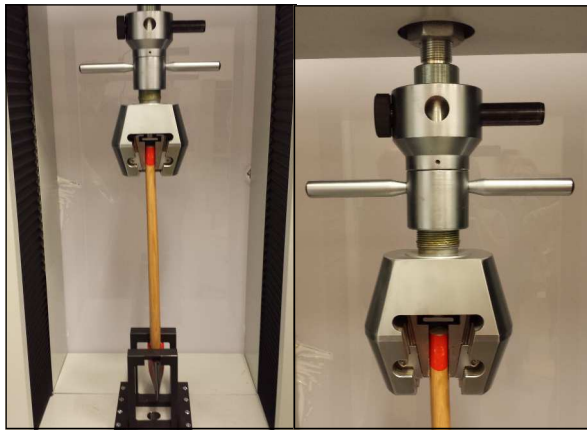

Bauteilprüfung an Äxten und Hämmern

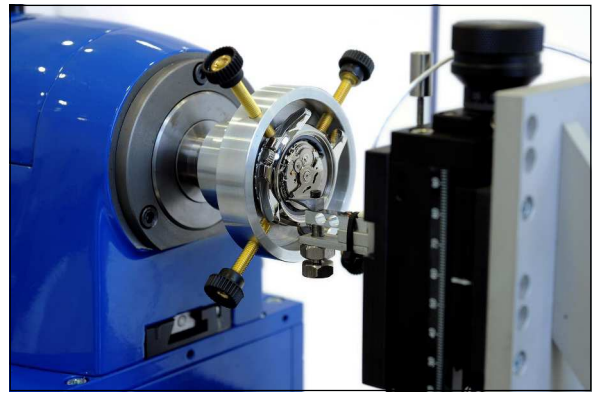

Torsionsprüfmaschine für die Feinmechanik



BCT Kartonprüfung (Verpackungsindustrie)



TestCenter für Druck-, Zug- und Torsionsprüfung



Vollautomatisierte Materialprüfmaschine